

kitagawa



Next Generation
Standard Chuck

BR series

Gripping accuracy
of
0.01 mm T.I.R.

For details on BR



<https://brchuck.com/en/>

Recd. the 2021 JSME Award (Technology)

Recd. the JSPE Monozukuri Award (2019)

Recd. the JSPE Chugoku Shikoku Branch Technology Award (2019)

Tnut-Plus



No need for reforming
after jaw detachment!

Time saving 

Cost saving 

BR-AJC



Upgrade your standard BR
to a quick jaw change chuck!



Next Generation Standard Chuck

BR SERIES

Pat. No. 6411619
Pat. No. 6345321

1 Gripping accuracy is 0.01mm T.I.R. or less

note 1)

Its unprecedented gripping accuracy overturns the commonsense of conventional standard chucks and it can be also used for finish processes!

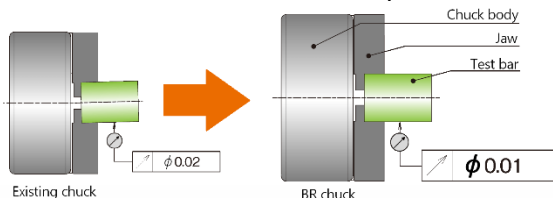

2 Reduced jaw-lift ensures stable machining quality

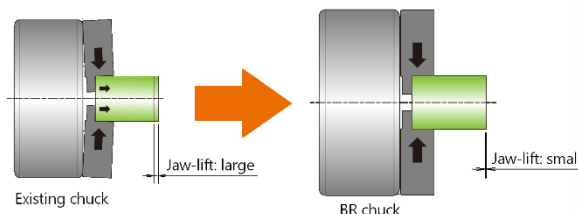

3 Interchangeable with Kitagawa B-200 & BB200 Existing cylinder can be used

Tnut-Plus



Pat. No. 6345375

With optional T-nuts, it will become more accurate.

Maintaining the repeatability of 0.01mm T.I.R. or less after changing jaws. (0.015mm T.I.R. for BR/BRT12)
The jaw mounting position has extremely high repeatability, so it will reproduce the state before removal.

1 Eliminating jaw-reforming at setup change

Significant reduction of setup time
3 setup changes per day, 30 minutes jaw forming per setup change

1.5-hour reduction per day!

*This estimate is based on the case of using a 3-jaw chuck.

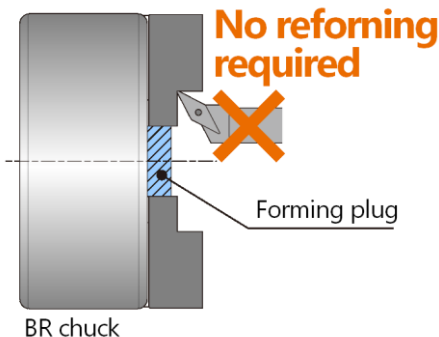

2 Kitagawa standard soft jaws (SJ) are used for Tnut-Plus.

* High repeatability can be realized only with Kitagawa genuine soft jaws.
Use of third-party jaws may cause detection of repeatability, sliding surface seizure or damage to parts.

Note 1) The gripping accuracy is the Total Indicator Reading of the test bar right after forming jaws.

Note 2) The repeatability is the amount of the test bar runout measured by detaching the formed jaws from the chuck and mounting them again in the same position.

Note 3) Both the gripping accuracy and repeatability are the amount of test bar runout measured 10mm apart from the top end of Kitagawa standard jaw.

The above criteria are based on Kitagawa internal regulations.

A standard BR chuck can be transformed into a quick jaw change chuck!

1 Existing BR/BRT chuck and soft jaws can be used as is for quick jaw change chuck.

The initial investment is lower compared to special chucks.

2 There is no installation mistake in the serration positioning, no matter who replaces the jaws.

3 Gripping accuracy is 0.01mm T.I.R. even when the jaws are detached and attached. No jaw reforming required.

Note) Only BR/BRT12's accuracy is 0.015mm T.I.R.

How to use

The setting is completed by forming the jaws on the lathe and screwing the positioning nut until it hits the end of master jaw and then locking it.

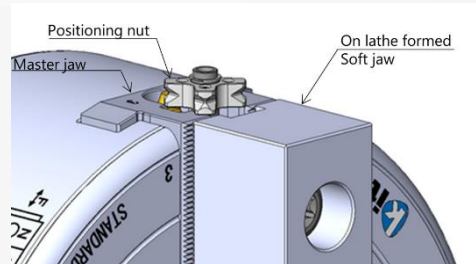

The preset positioning nut hits the end of the master jaw and stops insertion of a jaw

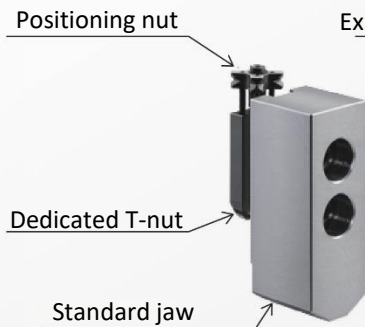

The soft jaw pre-formed and fitted with positioning nut

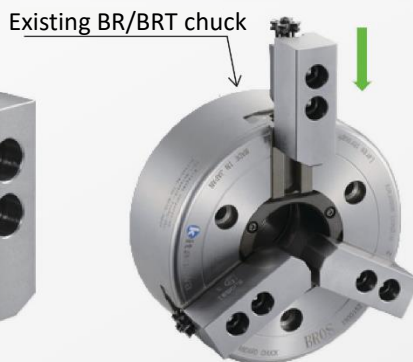

Insert the T-nut with soft jaw set into the master jaw



Simply tighten the jaw mounting bolts at the position where the positioning nut hits the master jaw

Compatibility

BR series

BRT series

HRS series

DLR series



Tnut-Plus



BR-AJC_M



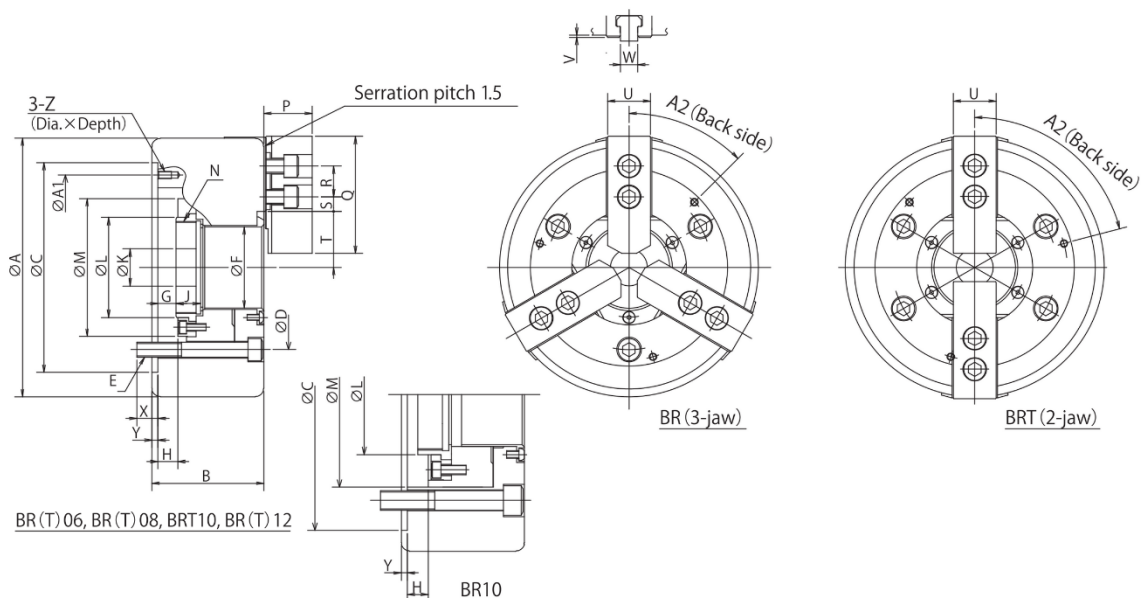

Dimensions ※Blank draw nut equipped.

Dimensions Model	A	B	C (H6)	D	E	F	G max.	G min.	H max.	H min.	J	K	L	M
BR06	170	81	140	104.8	3-M10	53	11	-1	12	0	17.5	20	66	89.7
BR08	210	91	170	133.4	3-M12	66	14.5	-1.5	16	0	20	30	81	111.6
BR10	254	100	220	171.4	3-M16	81	8.5	-10.5	19	0	25	45	97	150
BR12	315	108	300	235	3-M20	106	8	-15	23	0	28	50	124	166.7
BRT06	170	81	140	104.8	4-M10	53	11	-1	12	0	17.5	20	66	89.7
BRT08	210	91	170	133.4	4-M12	66	14.5	-1.5	16	0	20	30	81	111.6
BRT10	254	100	220	171.4	4-M16	81	8.5	-10.5	19	0	25	45	97	138.7
BRT12	315	108	300	235	4-M20	106	8	-15	23	0	28	50	124	166.7

Dimensions Model	N max.	P	Q	R	S max.	S min.	T max.	T min.	U	V	W	X	Y	Z	A1	A2
BR06	M60×2	33.2	72	20	21.25	9.25	36.05	33.3	31	2	12	16	5	M6×11	116	90°
BR08	M75×2	39.2	95	25	23.75	11.75	45.5	41.8	35	2	14	17	5	M6×11	150	45°
BR10	M90×2	43.2	110	30	32.25	11.25	54	49.6	40	2	16	22	5	M8×15	190	75°
BR12	M115×2	52	111	30	45.75	12.75	68.8	63.5	50	2.8	21	29	6	M10×16	260	75°
BRT06	M60×2	33.2	72	20	21.25	9.25	36.05	33.3	31	2	12	16	5	M6×11	116	90°
BRT08	M75×2	39.2	95	25	24	12	45.5	41.8	35	2	14	17	5	M6×11	150	75°
BRT10	M90×2	43.2	110	30	32.5	11.5	54	49.6	40	2	16	22	5	M8×15	190	75°
BRT12	M115×2	52	111	30	45.75	12.75	68.8	63.5	50	2.8	21	29	6	M10×16	260	75°

Specifications ※The weight and the moment of inertia include mounting bolts and soft jaws. The calculation is assuming that the master jaws are at the centre of stroke and soft jaws are at as of the outline drawing.

Specifications Model	Thru-hole mm	Gripping range mm	Jaw stroke (diameter) mm	Plunger stroke mm	Max. speed min ⁻¹	Max. draw bar pull force kN(kgf)	Max. gripping force kN(kgf)	Dynamic gripping force at max. speed kN(kgf)	Net weight kg	Moment of inertia kg·m ²	Matching cylinder	Max. pressure MPa(kgf/cm ²)	Matching soft jaw
BR06	53	170 / 16	5.5	12	6000	23	58.5	22.5	12.8	0.052	SR1453C SS1453K	2.3 2.1	SJ06B1
BR08	66	210 / 22	7.4	16	5000	35	90	36	22.2	0.14	SR1566C SS1666K	3.2 2.5	SJ08B1
BR10	81	254 / 31	8.8	19	4500	49	123	44	35.8	0.32	SR1781C SS1881K	3.4 3.1	SJ10B1
BR12	106	315 / 44	10.6	23	3500	60	156	53	57.0	0.80	SS2110K	3.0	SJ12N1
BRT06	53	170 / 20	5.5	12	6000	15.3	39	16	12.5	0.05	SR1453C SS1453K	1.6 1.5	SJ06A1T
BRT08	66	210 / 28	7.4	16	5000	23.3	60	29	21.7	0.13	SR1566C SS1666K	2.2 1.8	SJ08A1
BRT10	81	254 / 38	8.8	19	4500	32.7	82	29.4	34.9	0.32	SR1781C SS1881K	2.3 2.2	SJ10A1
BRT12	106	315 / 54	10.6	23	3500	40	104	44.2	56.2	0.78	SS2110K	2.1	SJ12N1

For more information on BR Chuck and other technical information on Kitagawa products, visit the Kitagawa Web Showroom.
<https://prod.kiw.co.jp/exhibition/mtools/en>



kitagawa

<https://www.kiw.co.jp>

<https://www.kitagawa.com>

<https://www.kitagawa.com.cn>

Kitagawa Corporation Kitagawa Global hand Company

77-1 Motomachi, Fuchu-shi, Hiroshima-pref. 726-8610, Japan Tel. +81 847-40-0561 Fax. +81 847-45-8911

- Specifications and outside appearance are subject to change without notice due to ongoing research and development.
- The color of the actual product may be different from the catalogue's due to printing matters.
- Catalogue contents as of 2024.4
- The products herein are controlled under Japanese Foreign Exchange and Foreign Trade Control Act. In the event of importing and/or exporting the products, You are obliged to consult KITAGAWA as well as your government for the related regulation prior to any transaction.